

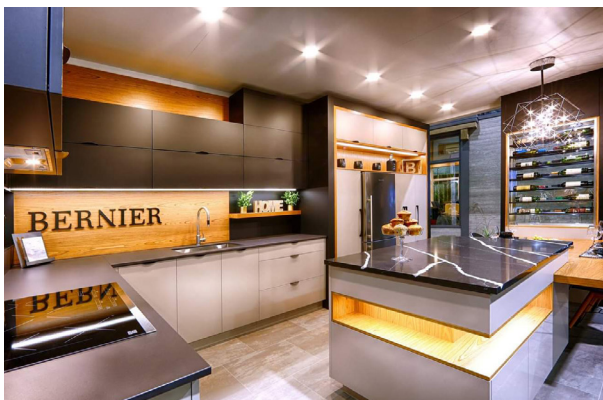

Ruban DEL

LS-STRIP-24V

Ruban DEL 24 V offrant une luminosité constante et une performance durable. Fait au Québec - Canada.

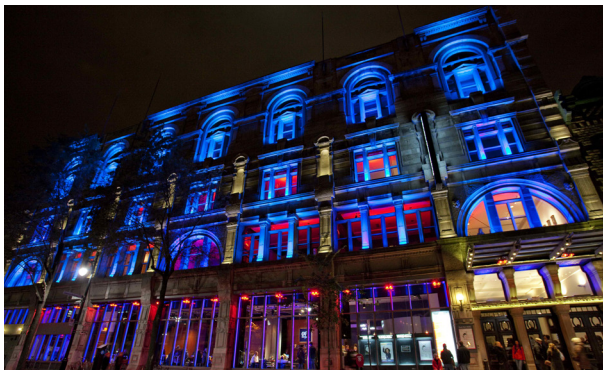
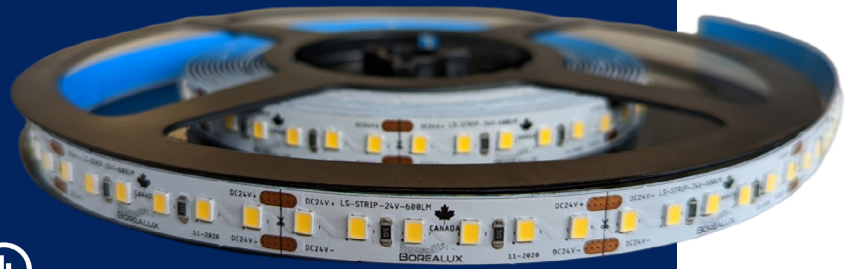

DESCRIPTION

CRI 80+(B CHIP) ou CRI 90+ (BRIDGELUX CHIP)

SMD 2835

Puissance 300lm/3W, 400lm/4W, 600lm/6W

Fabriqué au Canada

Durée de vie de 50 000hrs +

Température d'opération

Garantie 5 ans

3-Step MacAdam's ellipse, single binning

Protection connection inverse

3 oz de cuivre

Protection IP20 ou IP65

DIMENSIONS



TABLEAU DE COMMANDE - RUBANS 24V

1 RUBAN	2 LUMEN	3 CRI	4 CCT	5 PROTECTION	6 LONGUEUR	7 UNITÉ
LS-STRIP-24V						

8 FIL D'ENTRÉE	9 UNITÉ	10 FIL DE SORTIE	11 UNITÉ

Légende

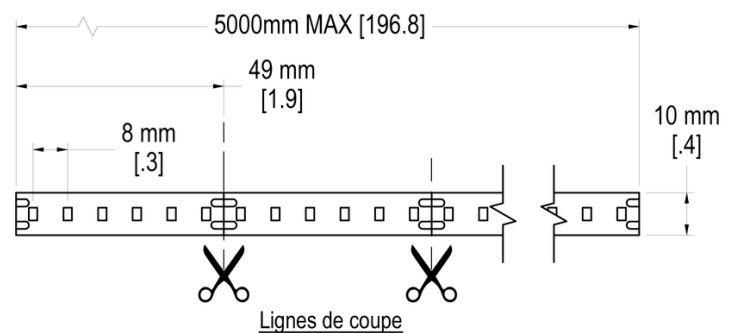
Référez-vous au chiffre correspondant de la case pour les informations à indiquer.

2

- 300 LM
- 400 LM
- 600 LM
- 800 LM
- CCT.VAR
- RGBW
- HP
- LL
- MINI-200 LM

3

- 80
- 90

4

- 2 700 K
- 3 000 K
- 3 500 K
- 4 000 K
- 5 000 K
- Sur demande

5

- IP20
- IP65

6 8 10

Indiquer longueur souhaitée.
 Pour le fil d'entrée et de sortie, vous pouvez indiquer : standard.

7 9 11

Indiquer l'unité de mesure de la longueur indiquée :
 • Mètres
 • Pouces
 • Pieds

SPÉCIFICATION DES PRODUITS

		24V-300LM	24V-400LM	24V-600LM	24V-800LM	24-CCT.VAR			24V-RGBW	24V-HP	24V-LL	24V-MINI-200LM
TYPE DE COULEUR												
CCT	K	2700K - 3000K - 3500K - 4000K - 5000K				3000K	4000K	5000K	RGBW 4000K	2700K 3000K 3500K 4000K 5000K	2700K 3000K 3500K 4000K 5000K	2700K 3000K 3500K 4000K 5000K
	sur demande	OUI	OUI	OUI	OUI	OUI	OUI	OUI	OUI	OUI	OUI	OUI
PUISSANCE	W/m	13,12	16,4	19,69	26,25	15,42	30,84	15,42	14,76	32,81	13,12	8,2
	W/pied	4	5	6	8	4,7	9,4	4,7	4,5	10	4	2,5
EFFICACITÉ LUMINEUSE	lm/W	984,25	1312,34	1968,51	2624,67	1962,74	1995,07	3878,53	1312,34	3280,84	1312,34	656,17
	lm/pied	300	400	600	800	598	608	1182	400	1000	400	200
CRI		80+/90+	80+/90+	80+/90+	80+/90+	90+	90+	90+	90+	80+/90+	80+/90+	80+
DISPONIBLE EN IP65+		OUI	OUI	OUI	OUI	NON	NON	NON	OUI	OUI	OUI	OUI
INCRÉMENT DE COUPE DU RUBAN DEL	mm	49	49	49	49	76	76	76	49	49	100	29
	pouce	1,9	1,9	1,9	1,9	3	3	3	1,9	1,9	3,94	1,14
QUANTITÉ DE PUCES DEL	LED/m	125	125	125	125	125	125	125	62	125	62	230
	LED/pied	38	38	38	38	38	38	38	19	38	19	70
LARGEUR DU RUBAN LED	mm	10	10	10	10	10	10	10	12	10	10	4
	pouce	0,39	0,39	0,39	0,39	0,39	0,39	0,39	0,47	0,39	0,39	0,16
LONGUEUR MAXIMUM	m	9,75	9,75	9,75	9,75	9,75	9,75	9,75	9,75	9,75	20,12	4,88
	pied	32	32	32	32	32	32	32	32	32	66	16
LIEN VERS LA PAGE PRODUIT												

RAPPORT PHOTOMÉTRIQUE EVERFINE

24V-300LM-80CRI-4000K

NOMINAL POWER	2.6 W	EFF	126.26 lm/W
RATED VOLTAGE	24 V	IMAX	103.9 cd
NOMINAL FLUX	328.278 lm	TOTAL FLUX	328.28 lm

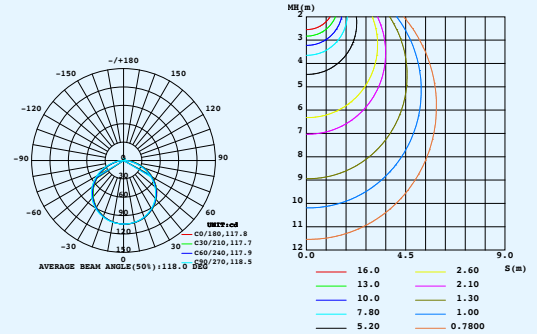

24V-600LM-80CRI-4000K

NOMINAL POWER	19.6 W	EFF	105.92 lm/W
RATED VOLTAGE	24 V	IMAX	657.9 cd
NOMINAL FLUX	2075.98 lm	TOTAL FLUX	2076.0 lm

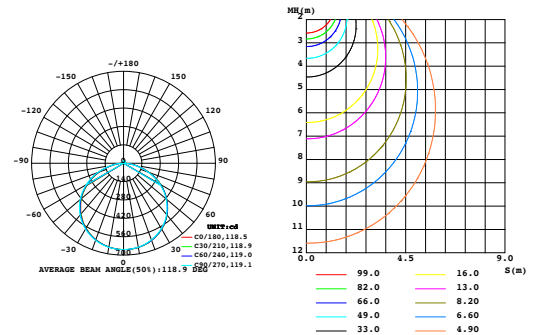

24V-600LM-90CRI-4000K

NOMINAL POWER	24.2 W	EFF	133.48 lm/W
RATED VOLTAGE	24 V	IMAX	1018 cd
NOMINAL FLUX	3220.25 lm	TOTAL FLUX	3230.2 lm

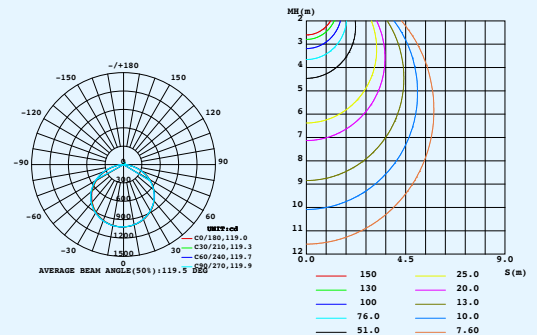

24V-4000K-mini

NOMINAL POWER	8 W	EFF	93.70 lm/W
RATED VOLTAGE	24 V	IMAX	234.0 cd
NOMINAL FLUX	749.578 lm	TOTAL FLUX	749.58 lm

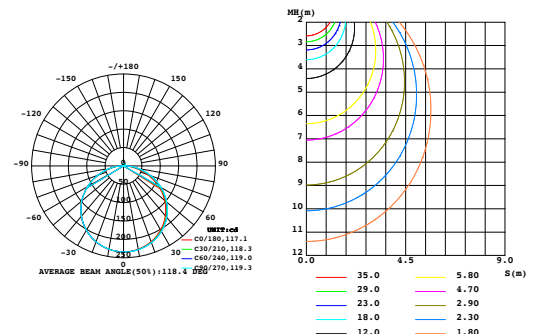

RAPPORT PHOTOMÉTRIQUE EVERFINE (SUITE)

24V-CCT-90CRI-3000K

NOMINAL POWER 15,2 W
RATED VOLTAGE 24 V
NOMINAL FLUX 1969.15 lm

EFF 129.55 lm/W
IMAX 614.0 cd
TOTAL FLUX 1969.1 lm

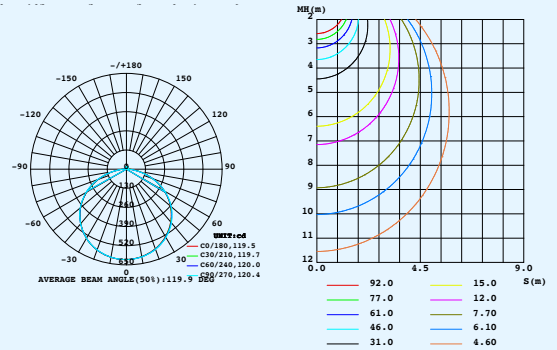

24V-CCT-90CRI-4000K

NOMINAL POWER 30.4 W
RATED VOLTAGE 24 V
NOMINAL FLUX 3823.39 lm

EFF 125.77 lm/W
IMAX 1188 cd
TOTAL FLUX 3823.4 lm

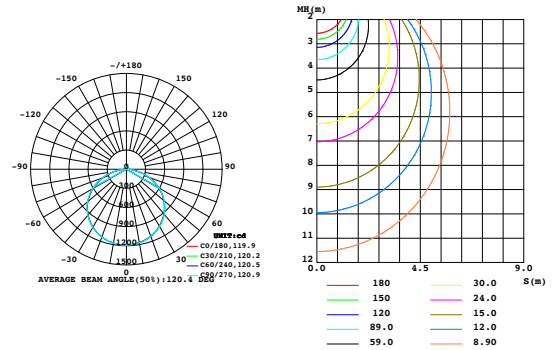

24V-CCT-90CRI-5000K

NOMINAL POWER 15.1 W
RATED VOLTAGE 24 V
NOMINAL FLUX 1913.31 lm

EFF 126.71 lm/W
IMAX 592.7 cd
TOTAL FLUX 1913.3 lm

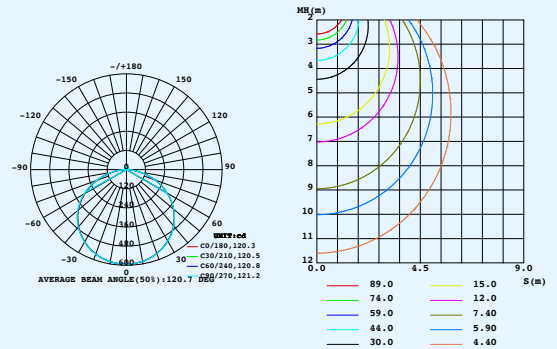

BLOCS D'ALIMENTATION

Pour plus
d'options



MODÈLE

BLOC D'ALIMENTATION

CARACTÉRISTIQUES

LS-PSU-24V-xxW-5IN1



- 24 Volts et disponibles en puissance de 96, 150, 200 et 300 Watts,
- Gradation de ligne (Triac MLV et ELV),
- PWM,
- 0-10V (sinc & source),
- Gradateur (potentiomètre intégré),
- Protection mauvais branchements,
- Classe P & 2,
- Conforme pour milieux humides

LS-PSU-24V-DIM-xxW



- 24 Volts et disponibles en puissance de 40 et 80 Watts,
- Gradation de ligne (TRIAC),
- IP20,
- Protection mauvais branchements,
- Classe 2

LS-PSU-12V-DIM-xxW



- 12 Volts et disponibles en puissance de 30, 40 et 80 Watts,
- Gradation de ligne (TRIAC),
- IP20,
- Protection mauvais branchements,
- Classe 2

LS-PSU-24V-120V/277V-xxW-IP67-B (0-10V)



- 24 Volts et disponibles en puissance de 100, 150, 240 et 320 Watts,
- Gradation 0-10V,
- IP67,
- Protection Courts-Circuits,
- Classe 1 div.2

ACCESSOIRES DE CONTRÔLES

Pour plus d'options



MODÈLE

BLOC D'ALIMENTATION

CARACTÉRISTIQUES

LS-CON-DMX -DE3

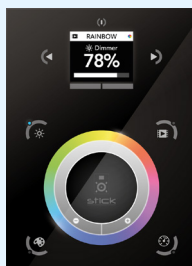

- Écran,
- 500 scènes,
- 10 zones,
- 1024 canaux DMX,
- USB,
- Ethernet

LS-CON-DMX-DINA-R2-LITE

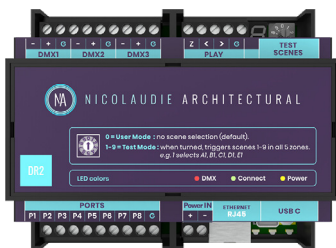

- Automome,
- 99 scènes,
- 5 zones,
- 3 univers DMX/RDM,
- DALI,
- USB,
- Ethernet

LS-CON-DMX-SLESA-U11



- 10 boutons,
- 99 scènes,
- 10 zones,
- 1024 canaux DMX,
- USB,
- Ethernet,
- Horloges et horaires

LS-CON-DEC-DMX-4S-6A



- Décodeur DMX de 4 canaux,
- Max 6A par canal

EXTRUSIONS POPULAIRES

Pour plus
d'options



MODÈLE

EXTRUSION

DIMENSIONS

LS-EXT-SUR-16*13

• Segment de 10 pieds

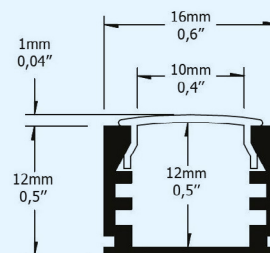
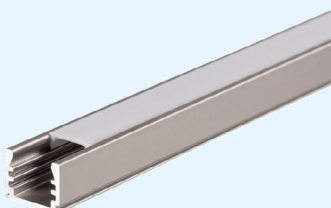

LS-EXT-SUR-CORNER

• Segment de 10 pieds

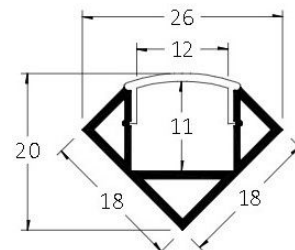

LS-EXT-T.BAR-2528

• Segment de 10 pieds

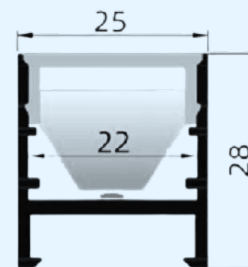
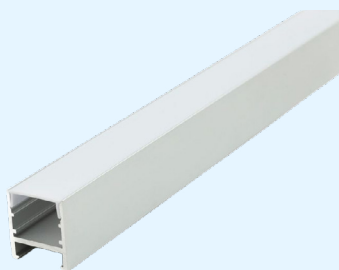

LS-EXT-ENC-22*13

• Segment de 10 pieds

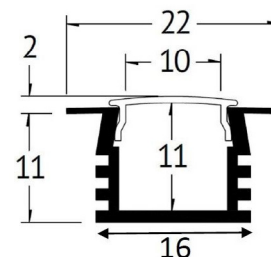

MONTAGE NEON FLEXIBLES POPULAIRES

Pour plus
d'options



MODÈLE

EXTRUSION

DIMENSIONS

LS-EXT-NEON-SIDE-16*16

- Segment de 10 pieds

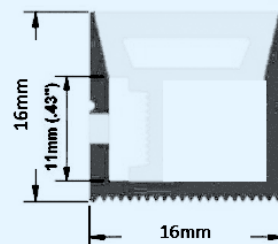

LS-EXT-NEON-TOP-16*16

- Segment de 10 pieds

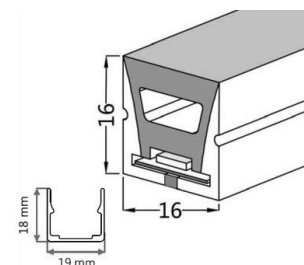

LS-EXT-NEON-TOP-20*20

- Segment de 10 pieds

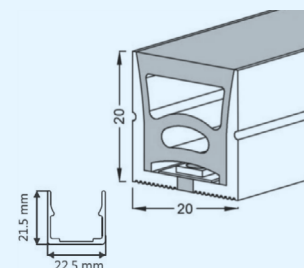

POURQUOI | WHY

BOREALUX



- **VÉRITABLE MANUFACTURIER** DEL Canadien
- **GARANTIES** de 5 ans
- Livraison **HYPER RAPIDE**
- **IMMENSE** capacité de production sur mesure

- **GENUINE CANADIAN** LED manufacturer
- 5 year **WARRANTIES**
- Very **FAST** delivery
- **HUGE** custom production capacity

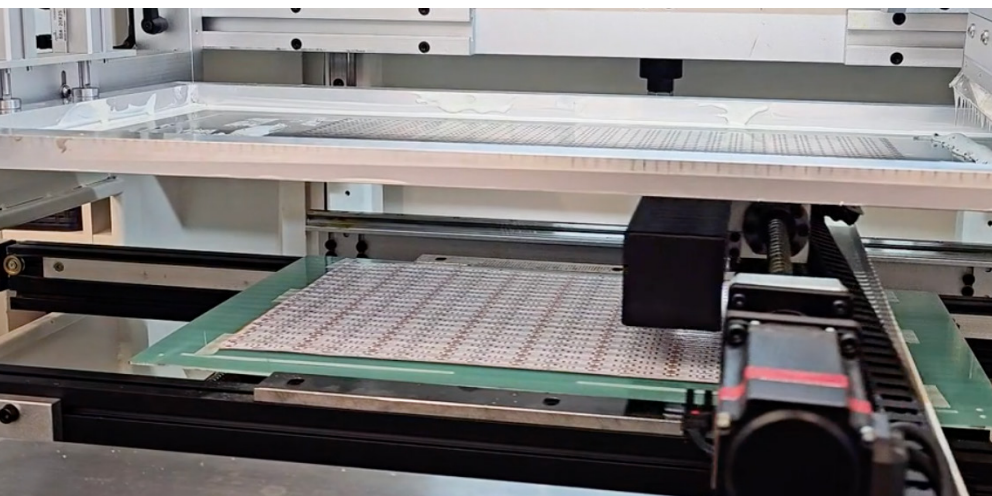

1-888-540-4713

vi@borealux.com

www.borealux.com

670 rue Bouvier, suite 108,
Québec (Qc) Canada G2J 1A7

DÉCOUVREZ TOUS NOS PRODUITS | DISCOVER ALL OUR PRODUCTS