

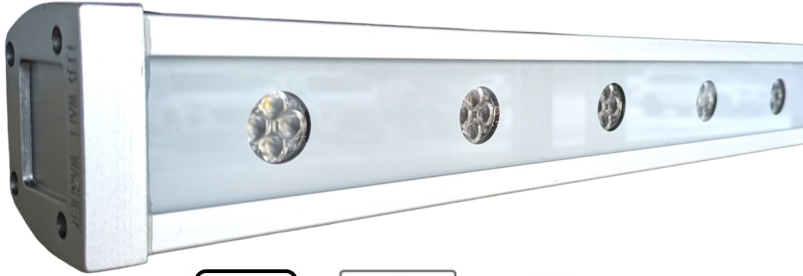

Client Date Qté
Projet Type BC#

LS-ARCH-EXT-120V-LIN



Description

***** GARANTIE de 5 ANS *****

- Châssis d'aluminium
- CCT: 2700K,3000K,3500K,4000K, 5000K ou RGBW
- DMX512, 0-10V
- Angle d'ouverture de 15° à 45°
- Finition argent (Finition noir sur demande)
- Protection IP66
- Pour éclairage architecturale de façade





Client Date Qté
Projet Type BC#

LS-ARCH-EXT-120V-LIN

Dimensions

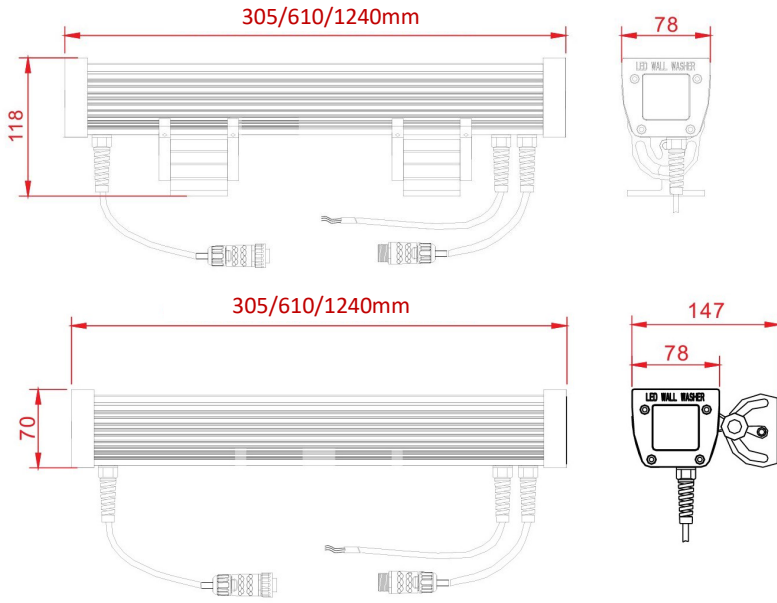

Installation

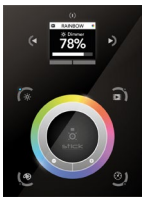

LS-CON-DMX-DE3

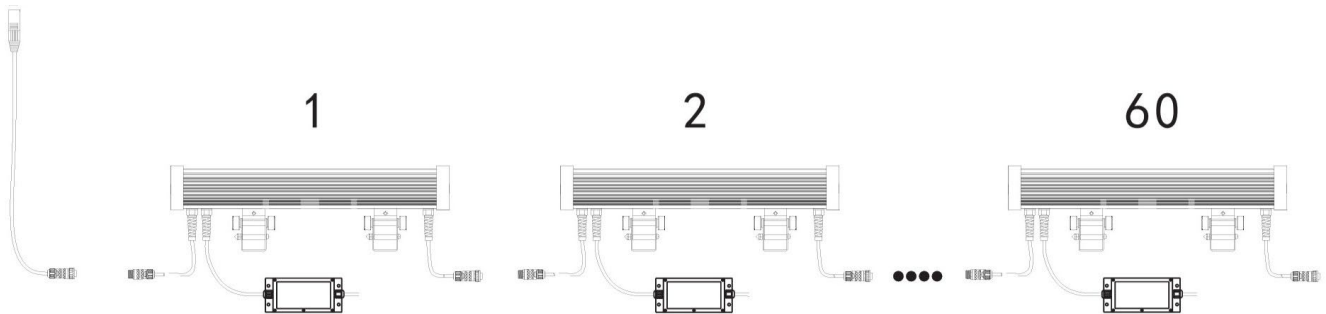



Client Date Qté
 Projet Type BC#

LS-ARCH-EXT-120V-LIN

Tableau de commande

Modèle	Protection	Puissance	Température couleur	Nombre de DEL	Voltage	Angle d'ouverture	Dimensions
LS-ARCH-EXT-120V-LIN-1.22M-2.7K	IP66	56W	2700K	48	120V	10,15,20,45°	Voir dessin
LS-ARCH-EXT-120V-LIN-1.22M-3K	IP66	56W	3000K	48	120V	10,15,20,45°	Voir dessin
LS-ARCH-EXT-120V-LIN-1.22M-3.5K	IP66	56W	3500K	48	120V	10,15,20,45°	Voir dessin
LS-ARCH-EXT-120V-LIN-1.22M-4K	IP66	56W	4000K	48	120V	10,15,20,45°	Voir dessin
LS-ARCH-EXT-120V-LIN-1.22M-5K	IP66	56W	5000K	48	120V	10,15,20,45°	Voir dessin
LS-ARCH-EXT-120V-LIN-1.22M-RGBW	IP66	56W	RGBW	48	120V	10,15,20,45°	Voir dessin

Modèle	Protection	Puissance	Température couleur	Nombre de DEL	Voltage	Angle d'ouverture	Dimensions
LS-ARCH-EXT-120V-LIN-610MM-2.7K	IP66	28W	T2700K	24	120V	10,15,20,45°	Voir dessin
LS-ARCH-EXT-120V-LIN-610MM-3K	IP66	28W	3000K	24	120V	10,15,20,45°	Voir dessin
LS-ARCH-EXT-120V-LIN-610MM-3.5K	IP66	28W	3500K	24	120V	10,15,20,45°	Voir dessin
LS-ARCH-EXT-120V-LIN-610MM-4K	IP66	28W	4000K	24	120V	10,15,20,45°	Voir dessin
LS-ARCH-EXT-120V-LIN-610MM-5K	IP66	28W	5000K	24	120V	10,15,20,45°	Voir dessin
LS-ARCH-EXT-120V-LIN-610MM-RGBW	IP66	28W	RGBW	24	120V	10,15,20,45°	Voir dessin

Modèle	Protection	Puissance	Température couleur	Nombre de DEL	Voltage	Angle d'ouverture	Dimensions
LS-ARCH-EXT-120V-LIN-305MM-2.7K	IP66	14W	2700K	12	120V	10,15,20,45°	Voir dessin
LS-ARCH-EXT-120V-LIN-305MM-3K	IP66	14W	3000K	12	120V	10,15,20,45°	Voir dessin
LS-ARCH-EXT-120V-LIN-305MM-3.5K	IP66	14W	3500K	12	120V	10,15,20,45°	Voir dessin
LS-ARCH-EXT-120V-LIN-305MM-4K	IP66	14W	4000K	12	120V	10,15,20,45°	Voir dessin
LS-ARCH-EXT-120V-LIN-305MM-5K	IP66	14W	5000K	12	120V	10,15,20,45°	Voir dessin
LS-ARCH-EXT-120V-LIN-305MM-RGBW	IP66	14W	RGBW	12	120V	10,15,20,45°	Voir dessin

Candela Distribution

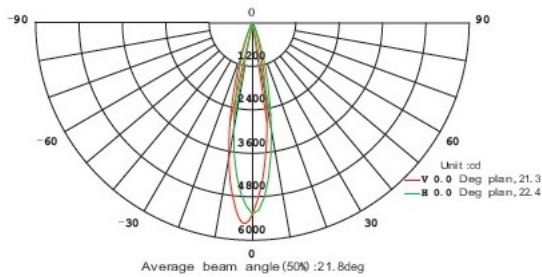

RGB

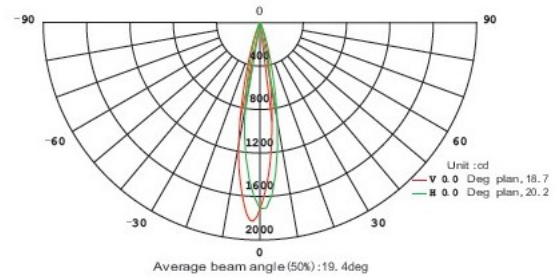

Red

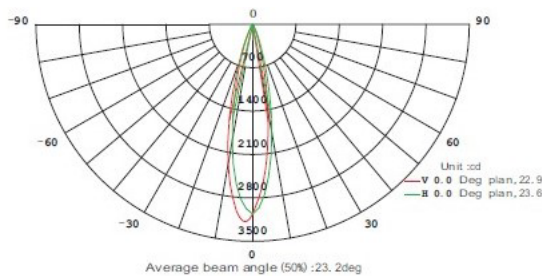

Green

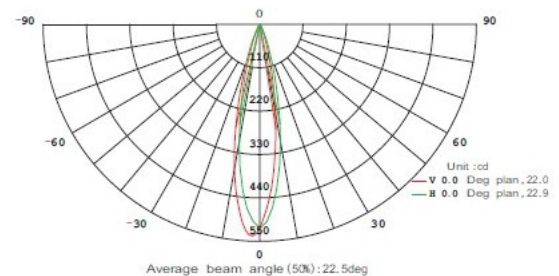

Blue



Client Date Qté
 Projet Type BC#

LS-ARCH-EXT-120V-LIN

Test photométrique

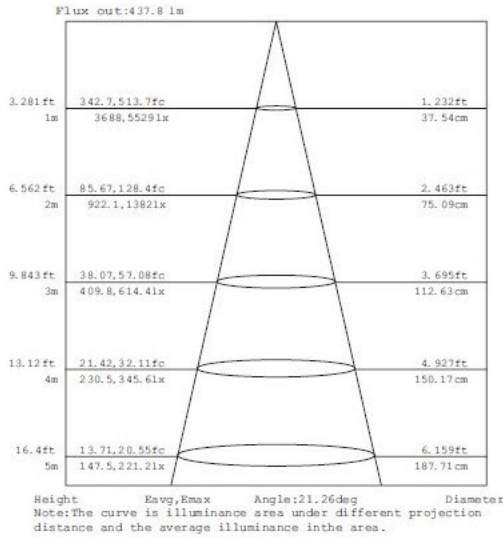

RGB

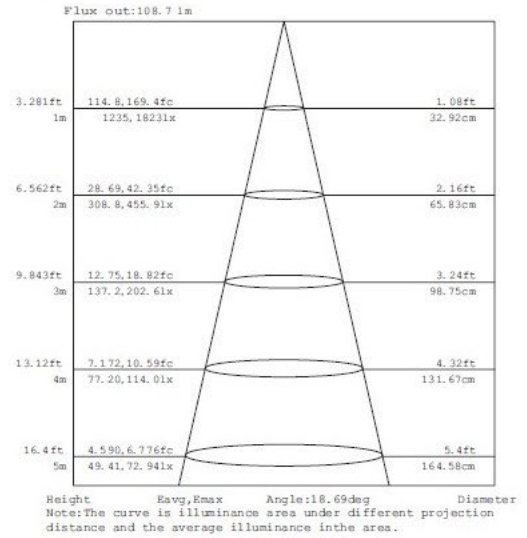

Red

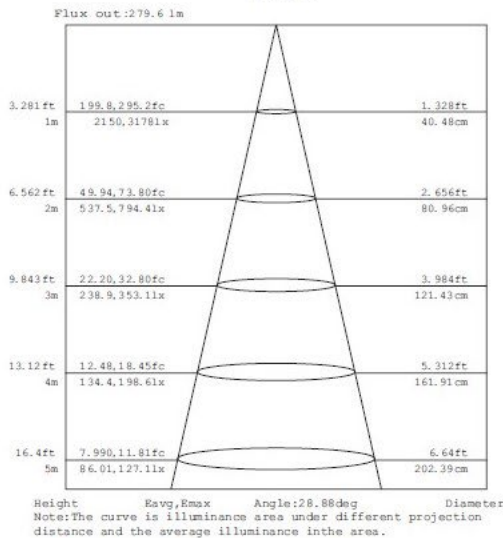

Green

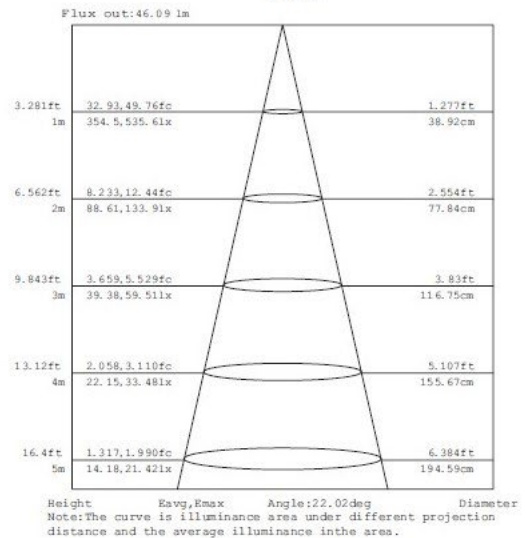

Blue