

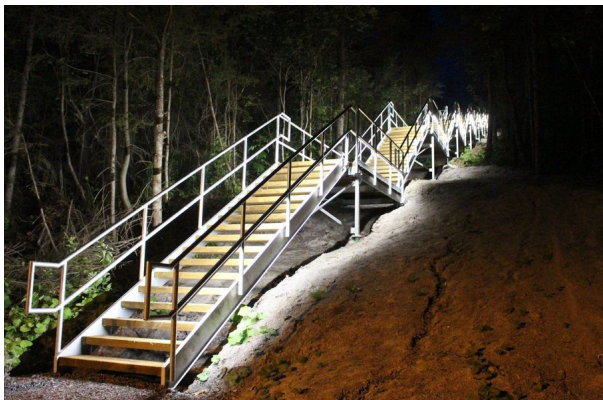

LED strip

## LS-STRIP-12V

DEL 12 V strip offering consistent brightness and long-lasting performance.  
 Made in Quebec - Canada

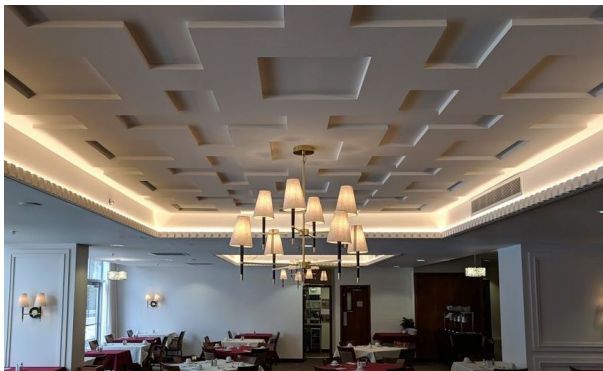
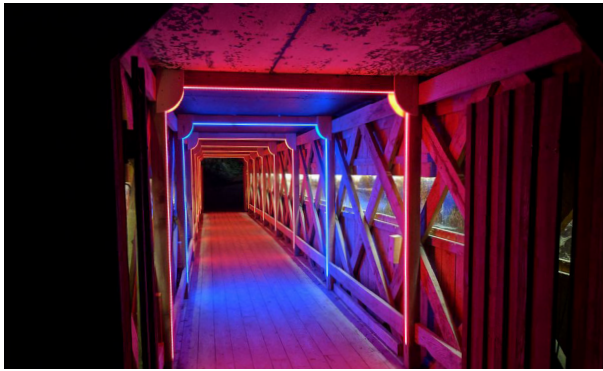

### DESCRIPTION

CRI 80+(B CHIP) or CRI 90+ (BRIDGELUX CHIP)

SMD 2835 or 5050

Power 400lm/4W

Made in Canada

Lifetime of 50,000 hrs+

Operation temperature

5 year warranty

3-Step MacAdam's ellipse, single binning

Inverted connexion protection

3 oz copper

Protection IP20 or IP65

### DIMENSIONS

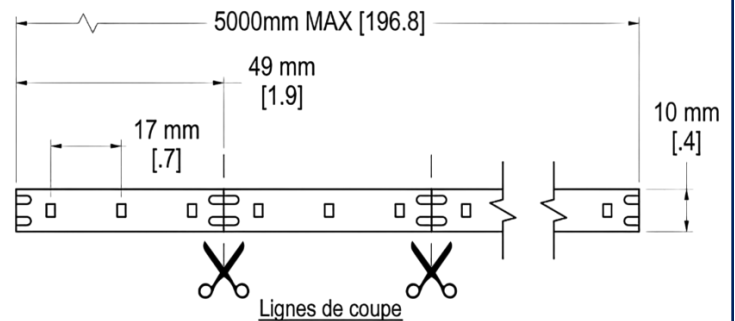

## ORDER SHEET - 12V STRIP

<b>1</b> STRIP	<b>2</b> LUMEN	<b>3</b> CRI	<b>4</b> CCT	<b>5</b> PROTECTION	<b>6</b> LENGTH	<b>7</b> UNIT
LS-STRIP-12V						
<b>8</b> INPUT WIRE	<b>9</b> UNIT	<b>10</b> OUTPUT WIRE	<b>11</b> UNIT			

**Legend**

Refer to the corresponding number in the box for the information to be provided.

**2**

- 400 LM
- RGBW

**3**

- 80
- 90

**4**

- 2700k
- 3000k
- 3500k
- 4000k
- 5000k
- RGBW 4000K

**5**

- IP20
- IP65

**6 8 10**

Specify the desired length.  
 For the input and output wires, you can specify: standard.

**7 9 11**

Select the unit of measurement for the length provided:

- Meters
- Inches
- Feet

## PRODUCT SPECIFICATIONS

		12V- RGBW	12V- 400LM
<b>COLOR TYPE</b>			
<b>CCT</b>	K	RGBW 4000K	2700K 3000K 3500K 4000K 5000K
	On demand	YES	YES
<b>POWER</b>	W/m	14,76	13,12
	W/ft	4,5	4
<b>LIGHT EFFICIENCY</b>	lm/W	1312,34	1312,34
	lm/ft	400	400
<b>CRI</b>		90+	80+/90+
<b>AVAILABLE IN IP65+</b>		YES	YES
<b>LED RIBBON CUTTING INCREMENT</b>	mm	49	49
	inch	1,9	1,9
<b>DIODE QTY</b>	LED/m	62	62
	LED/ft	19	19
<b>LED WIDTH</b>	mm	12	10
	inch	0,47	0,39
<b>MAX RUN LENGTH</b>	m	4,88	4,88
	feet	16	16
<b>LINK TO THE PRODUCT PAGE</b>			

## EVERFINE PHOTOMETRIC REPORT

### 12V-400LM-80CRI-4000K

<b>NOMINAL POWER</b>	15.3 W
<b>RATED VOLTAGE</b>	12 V
<b>NOMINAL FLUX</b>	1500.68 lm
<b>EFF</b>	98.08 lm/W
<b>IMAX</b>	465.1 cd
<b>TOTAL FLUX</b>	1500.7 lm

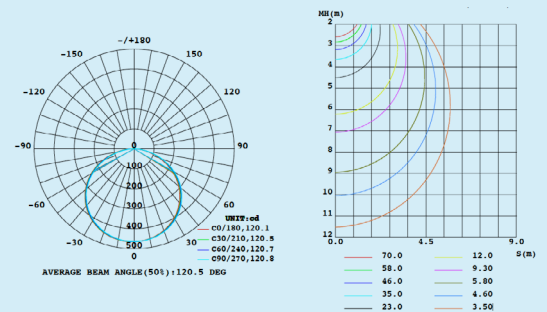

# POWER SUPPLY



## MODEL

## POWER SUPPLY

## SPECIFICATIONS

### LS-PSU-12V-DIM-30W



- 12 Volts and available in power ratings of 30, 40 et 80 Watts
- Wiring diagram (TRIAC)
- IP20
- Protection against incorrect wiring
- Class 2

### LS-PSU-12V-DIM-40W



- 12 Volts and available in power ratings of 30, 40 et 80 Watts
- Wiring diagram (TRIAC)
- IP20
- Protection against incorrect wiring
- Class 2

### LS-PSU-12V-DIM-80W



- 12 Volts and available in power ratings of 30, 40 et 80 Watts
- Wiring diagram (TRIAC)
- IP20
- Protection against incorrect wiring
- Class 2

# CONTROL



MODEL	CONTROL	SPECIFICATIONS
-------	---------	----------------

**LS-CON-DMX -DE3**

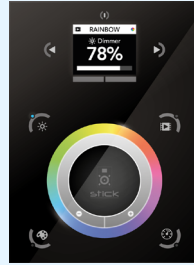

- Screen,
- 500 scenes,
- 10 zones,
- 1024 DMX channels,
- USB,
- Ethernet

**LS-CON-DMX-DINA-R2-LITE**

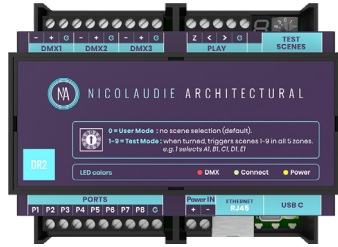

- Stand Alone controller
- 99 scenes,
- 5 zones,
- 3 DMX/RDM universes,
- DALI,
- USB,
- Ethernet

**LS-CON-DMX-SLESA-U11**



- 10 presets buttons,
- 99 scenes,
- 10 zones,
- 1024 DMX channels,
- USB,
- Ethernet,
- Clock and calendar

**LS-CON-DEC-DMX-4S-6A**



- 4-channel DMX decoder,
- Max 6A per channel

# POPULAR PROFILES

For more options



MODEL	PROFILE	DIMENSIONS
<p><b><u>LS-EXT-SUR-16*13</u></b></p> <ul style="list-style-type: none"> <li>• 10-foot segment</li> <li>• Compatible with 12V LED strips                             <ul style="list-style-type: none"> <li>- 400LM</li> <li>- RGBW</li> </ul> </li> </ul>		
<p><b><u>LS-EXT-SUR-CORNER</u></b></p> <ul style="list-style-type: none"> <li>• 10-foot segment</li> <li>• Compatible with 12V LED strips                             <ul style="list-style-type: none"> <li>- 400LM</li> <li>- RGBW</li> </ul> </li> </ul>		
<p><b><u>LS-EXT-T.BAR-2528</u></b></p> <ul style="list-style-type: none"> <li>• 10-foot segment</li> <li>• Compatible with 12V LED strips                             <ul style="list-style-type: none"> <li>- 400LM</li> <li>- RGBW</li> </ul> </li> </ul>		
<p><b><u>LS-EXT-ENC-22*13</u></b></p> <ul style="list-style-type: none"> <li>• 10-foot segment</li> <li>• Compatible with 12V LED strips                             <ul style="list-style-type: none"> <li>- 400LM</li> <li>- RGBW</li> </ul> </li> </ul>		

# POPULAR FLEXIBLE NEONS

For more options



MODEL	PROFILE	DIMENSIONS
<p><b><u>LS-EXT-NEON-SIDE-16*16</u></b></p> <ul style="list-style-type: none"> <li>• 10-foot segment</li> <li>• Compatible with 12V LED strips - 400LM</li> </ul>		
<p><b><u>LS-EXT-NEON-TOP-16*16</u></b></p> <ul style="list-style-type: none"> <li>• 10-foot segment</li> <li>• Compatible with 12V LED strips - 400LM</li> </ul>		
<p><b><u>LS-EXT-NEON-TOP-20*20</u></b></p> <ul style="list-style-type: none"> <li>• 10-foot segment</li> <li>• Compatible with 12V LED strips - 400LM - RGBW</li> </ul>		

POURQUOI | WHY

# BOREALUX



- **VÉRITABLE MANUFACTURIER** DEL Canadien
- **GARANTIES** de 5 ans
- Livraison **HYPER RAPIDE**
- **IMMENSE** capacité de production sur mesure

- **GENUINE CANADIAN** LED manufacturer
- 5 year **WARRANTIES**
- Very **FAST** delivery
- **HUGE** custom production capacity

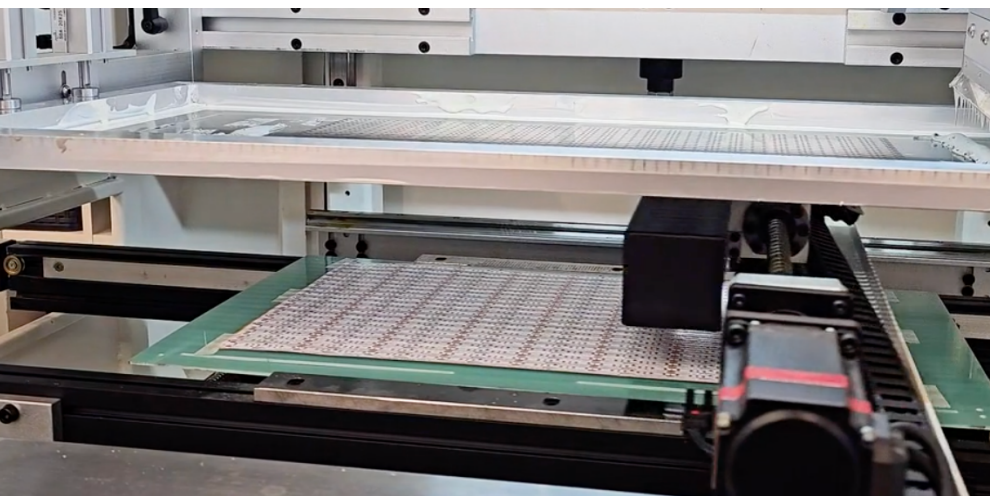
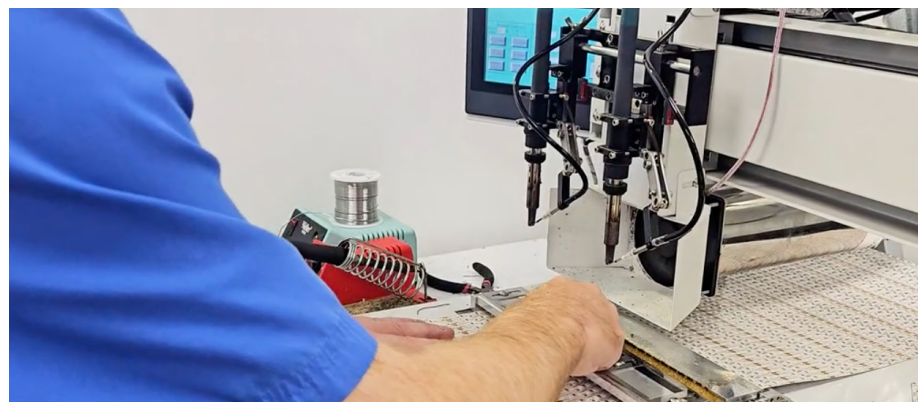

**1-888-540-4713**

**[vi@borealux.com](mailto:vi@borealux.com)**

**[www.borealux.com](http://www.borealux.com)**

670 rue Bouvier, suite 108,  
Québec (Qc) Canada G2J 1A7

**DÉCOUVREZ TOUS NOS PRODUITS | DISCOVER ALL OUR PRODUCTS**