



Client

Date

Qty

Project

Type

PO#

LS-ARCH-EXT-120V-LIN



Description

- Rugged Aluminium Chassis
- CCT: 2700K,3000K,3500K,4000K, 5000K or RGBW
- Control : 0-10V, DMX512
- Beam angle: 15° à 45°, 10°x10°
- Black or silver finish
- IP66 Protection
- For building facade lighting

***** GARANTIE de 5 ANS *****





Client

Date

Qty

Project

Type

PO#

LS-ARCH-EXT-120V-LIN

Dimensions

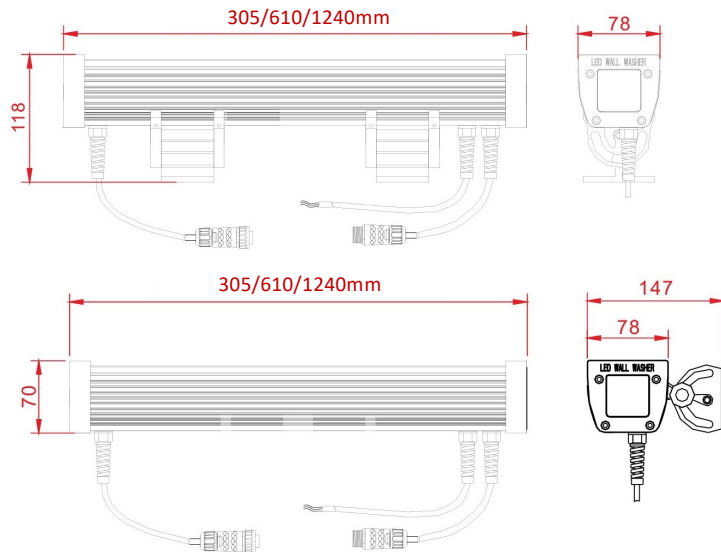

Installation

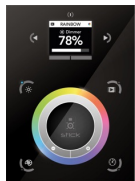

LS-CON-DMX-DE3
DMX CONTROLLER

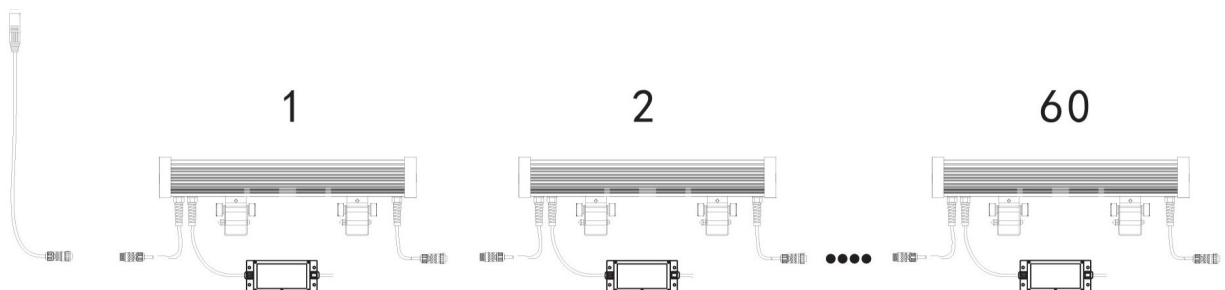



Client

Date

Qty

Project

Type

PO#

LS-ARCH-EXT-120V-LIN

Order table

| Modèle | Protection | Puissance | Température couleur | Nombre de DEL | Voltage | Angle d'ouverture | Dimensions |
|---------------------------------|------------|-----------|---------------------|---------------|---------|-------------------|-------------|
| LS-ARCH-EXT-120V-LIN-1.22M-2.7K | IP66 | 40W | 2700K | 48 | 120V | 10 à 45°,10°x10° | Voir dessin |
| LS-ARCH-EXT-120V-LIN-1.22M-3K | IP66 | 40W | 3000K | 48 | 120V | 10 à 45°,10°x10° | Voir dessin |
| LS-ARCH-EXT-120V-LIN-1.22M-3.5K | IP66 | 40W | 3500K | 48 | 120V | 10 à 45°,10°x10° | Voir dessin |
| LS-ARCH-EXT-120V-LIN-1.22M-4K | IP66 | 40W | 4000K | 48 | 120V | 10 à 45°,10°x10° | Voir dessin |
| LS-ARCH-EXT-120V-LIN-1.22M-5K | IP66 | 40W | 5000K | 48 | 120V | 10 à 45°,10°x10° | Voir dessin |
| LS-ARCH-EXT-120V-LIN-1.22M-RGBW | IP66 | 56W | RGBW | 48 | 120V | 10 à 45°,10°x10° | Voir dessin |

| Modèle | Protection | Puissance | Température couleur | Nombre de DEL | Voltage | Angle d'ouverture | Dimensions |
|---------------------------------|------------|-----------|---------------------|---------------|---------|-------------------|-------------|
| LS-ARCH-EXT-120V-LIN-610MM-2.7K | IP66 | 20W | T2700K | 24 | 120V | 10 à 45°,10°x10° | Voir dessin |
| LS-ARCH-EXT-120V-LIN-610MM-3K | IP66 | 20W | 3000K | 24 | 120V | 10 à 45°,10°x10° | Voir dessin |
| LS-ARCH-EXT-120V-LIN-610MM-3.5K | IP66 | 20W | 3500K | 24 | 120V | 10 à 45°,10°x10° | Voir dessin |
| LS-ARCH-EXT-120V-LIN-610MM-4K | IP66 | 20W | 4000K | 24 | 120V | 10 à 45°,10°x10° | Voir dessin |
| LS-ARCH-EXT-120V-LIN-610MM-5K | IP66 | 20W | 5000K | 24 | 120V | 10 à 45°,10°x10° | Voir dessin |
| LS-ARCH-EXT-120V-LIN-610MM-RGBW | IP66 | 28W | RGBW | 24 | 120V | 10 à 45°,10°x10° | Voir dessin |

| Modèle | Protection | Puissance | Température couleur | Nombre de DEL | Voltage | Angle d'ouverture | Dimensions |
|---------------------------------|------------|-----------|---------------------|---------------|---------|-------------------|-------------|
| LS-ARCH-EXT-120V-LIN-305MM-2.7K | IP66 | 10W | 2700K | 12 | 120V | 10 à 45°,10°x10° | Voir dessin |
| LS-ARCH-EXT-120V-LIN-305MM-3K | IP66 | 10W | 3000K | 12 | 120V | 10 à 45°,10°x10° | Voir dessin |
| LS-ARCH-EXT-120V-LIN-305MM-3.5K | IP66 | 10W | 3500K | 12 | 120V | 10 à 45°,10°x10° | Voir dessin |
| LS-ARCH-EXT-120V-LIN-305MM-4K | IP66 | 10W | 4000K | 12 | 120V | 10 à 45°,10°x10° | Voir dessin |
| LS-ARCH-EXT-120V-LIN-305MM-5K | IP66 | 10W | 5000K | 12 | 120V | 10 à 45°,10°x10° | Voir dessin |
| LS-ARCH-EXT-120V-LIN-305MM-RGBW | IP66 | 14W | RGBW | 12 | 120V | 10 à 45°,10°x10° | Voir dessin |

Candela Distribution

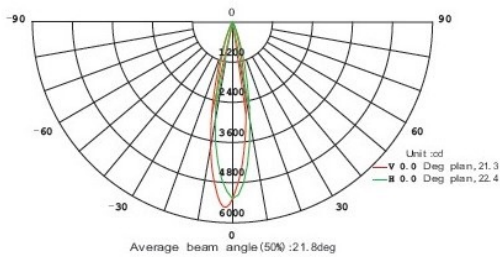

RGB

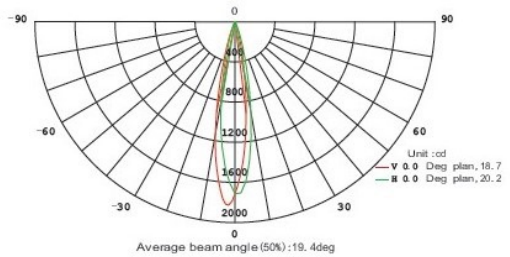

Red

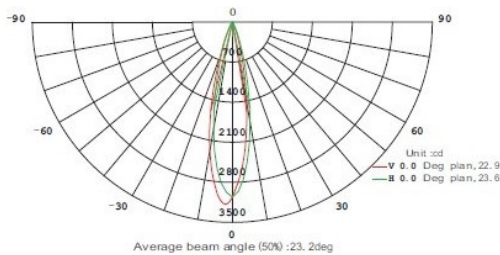

Green

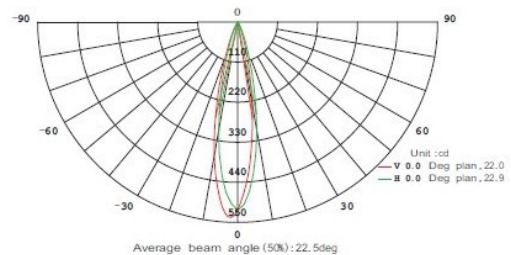

Blue



Client

Date

Qty

Project

Type

PO#

LS-ARCH-EXT-120V-LIN

Photometric test

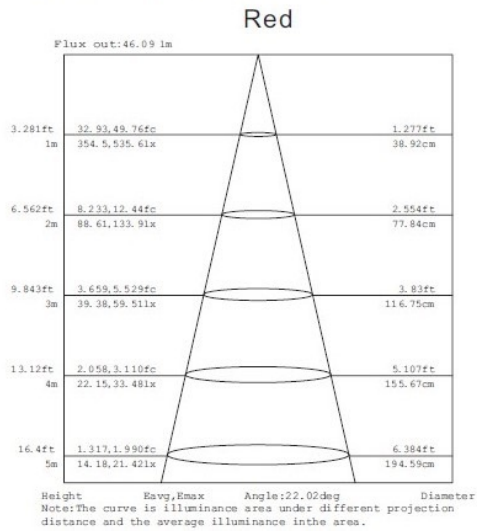
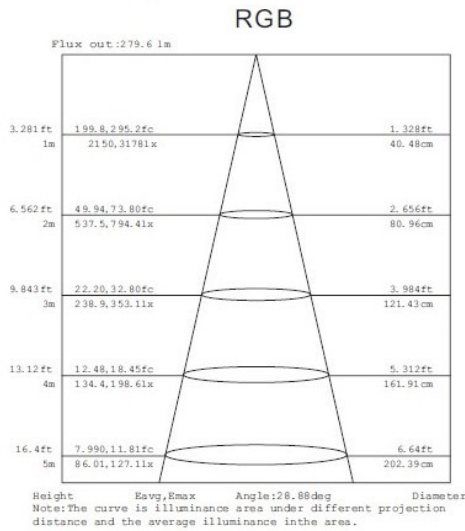
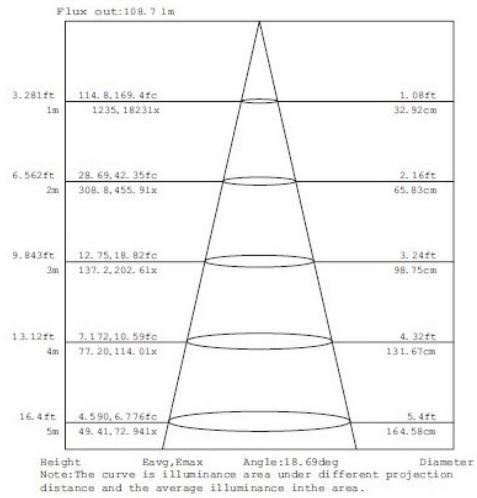
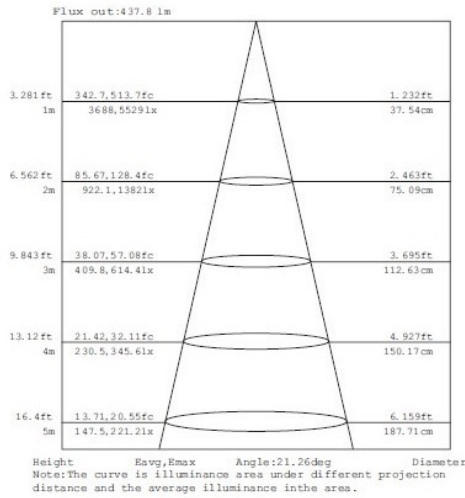

Green

Blue